

3.2 OVERALL CONNECTION DIAGRAM(GUIDE PAGE)

Note: When ordering service parts, be sure to refer to "EXPLODED VIEWS AND PARTS LIST" or "ELECTRICAL PARTS LIST".

A
B
C
D
E
F

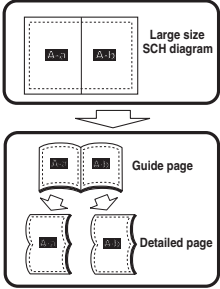

A-a

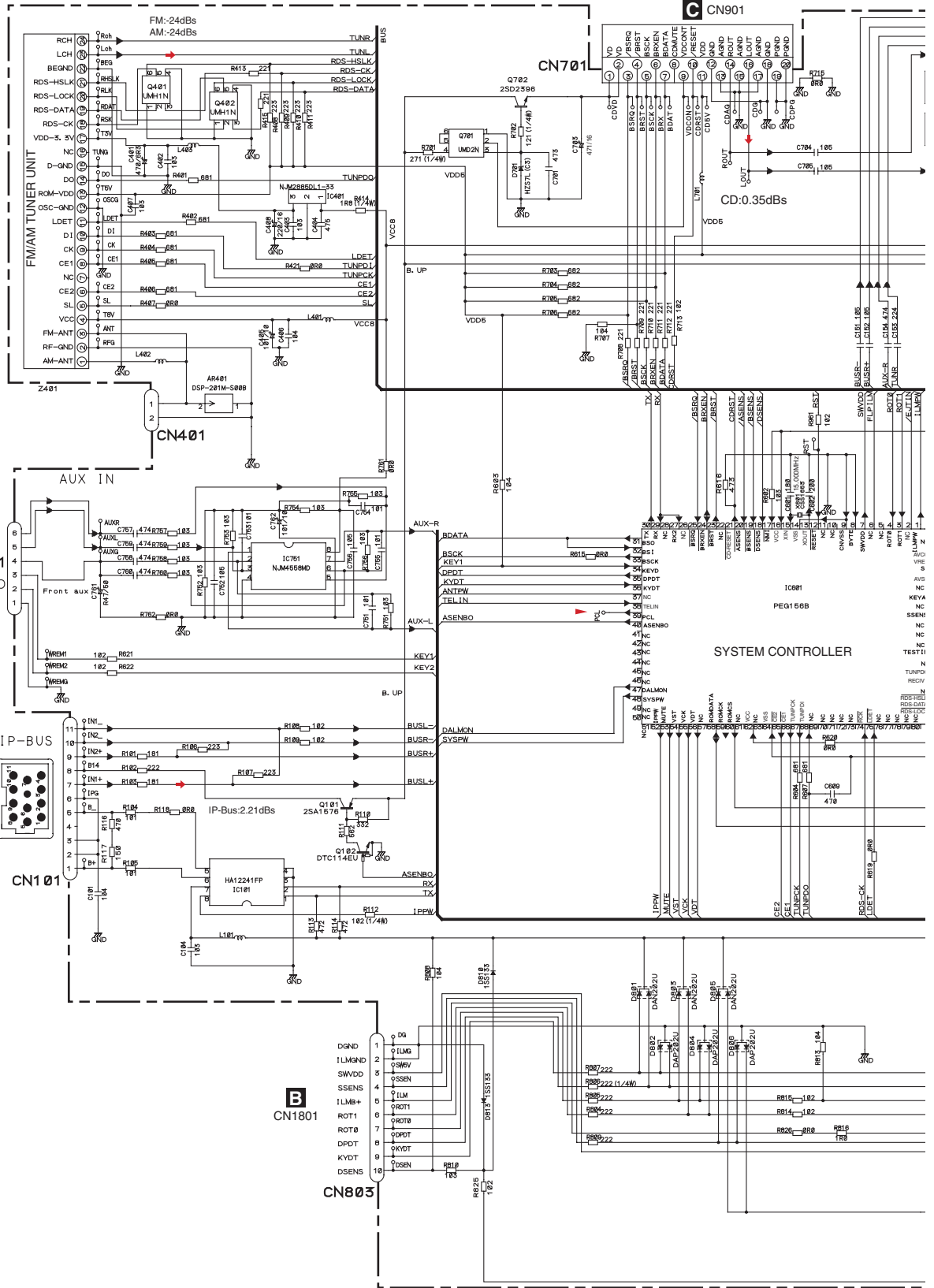

A-b

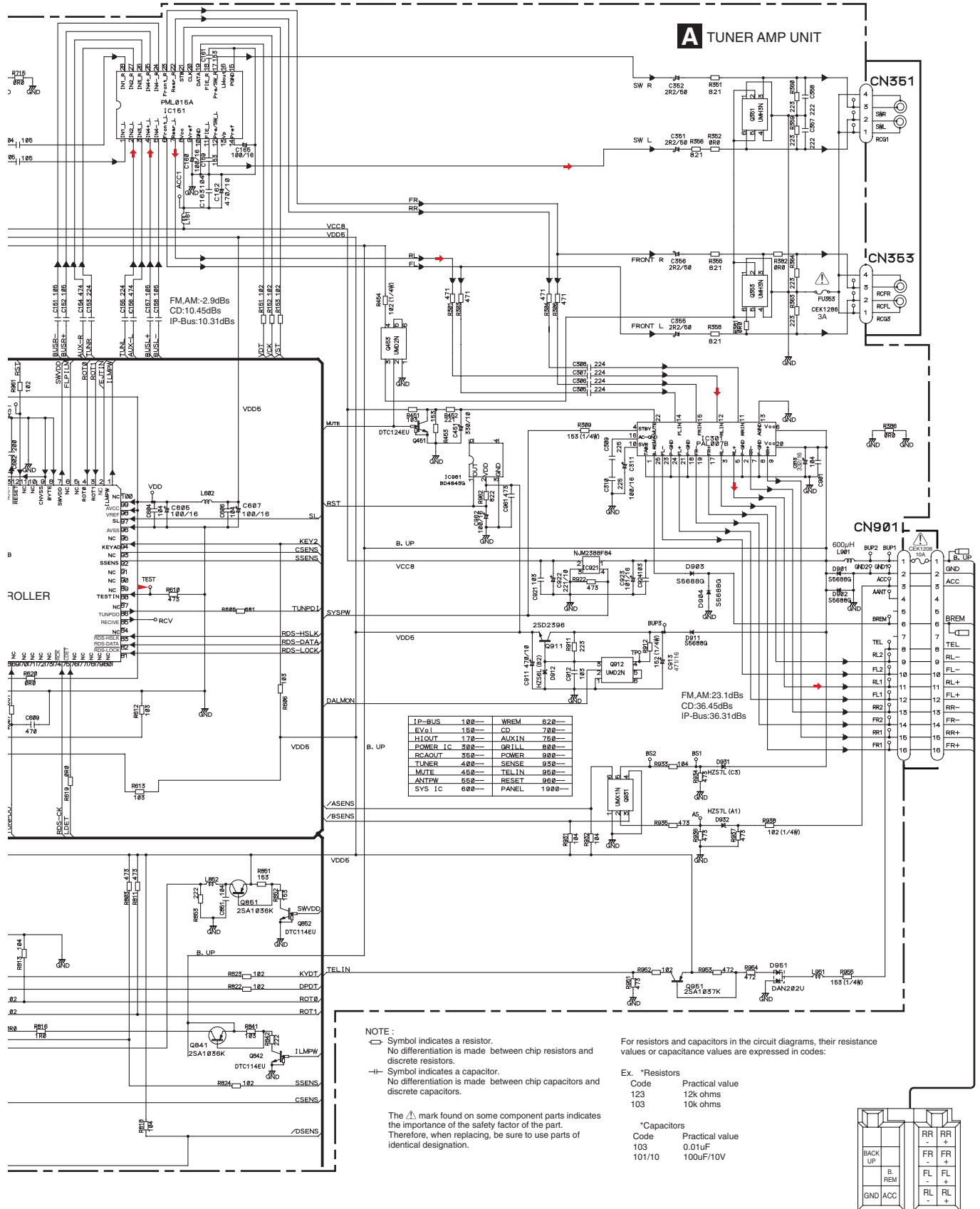

A
B
C
D
E
F

A

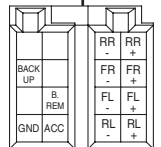

3.3 KEYBOARD UNIT

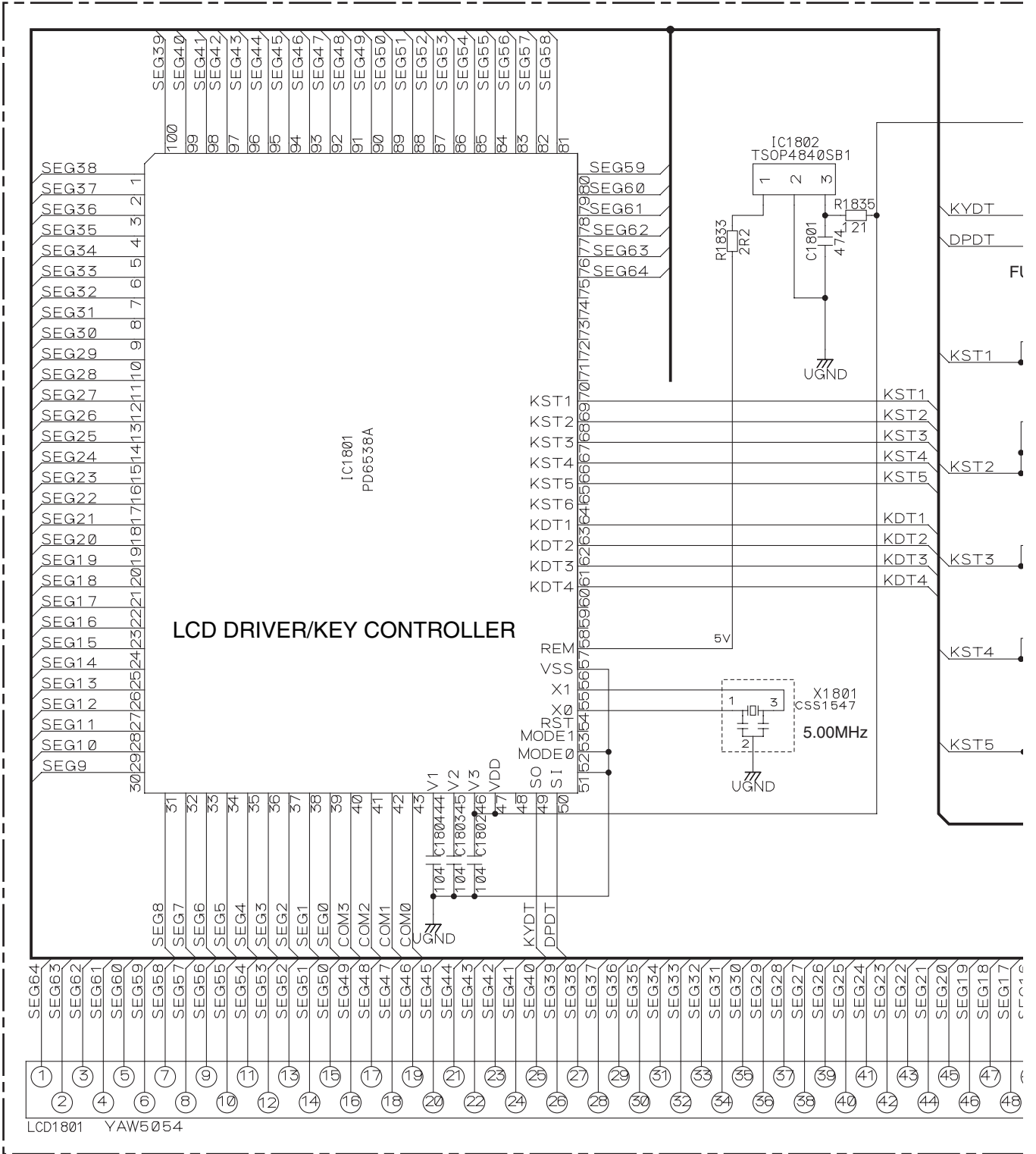

B

B KEYBOARD UNIT

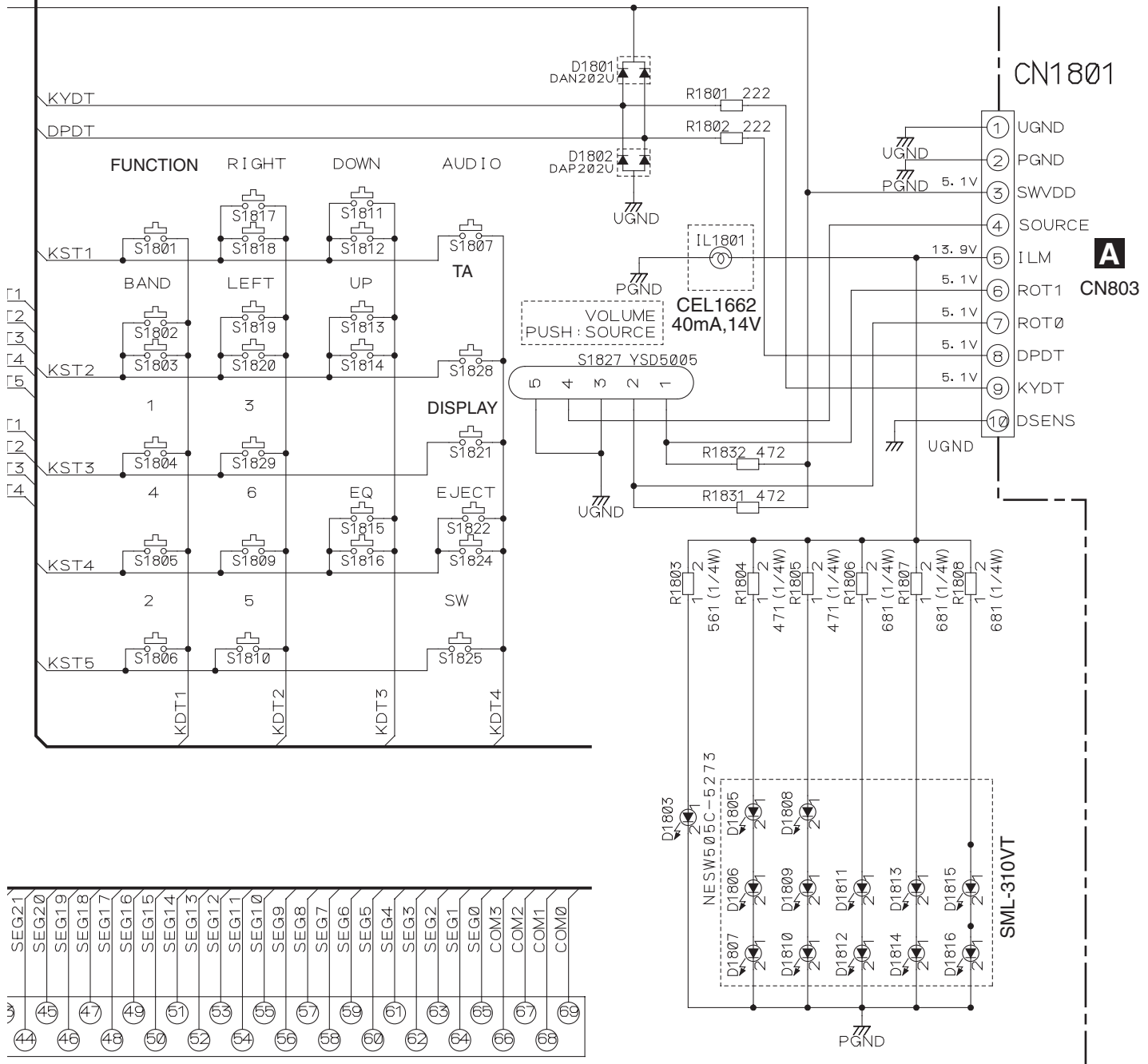

A
B
C
D
E
F

B

3.4 CD MECHANISM MODULE(GUIDE PAGE)

C-a

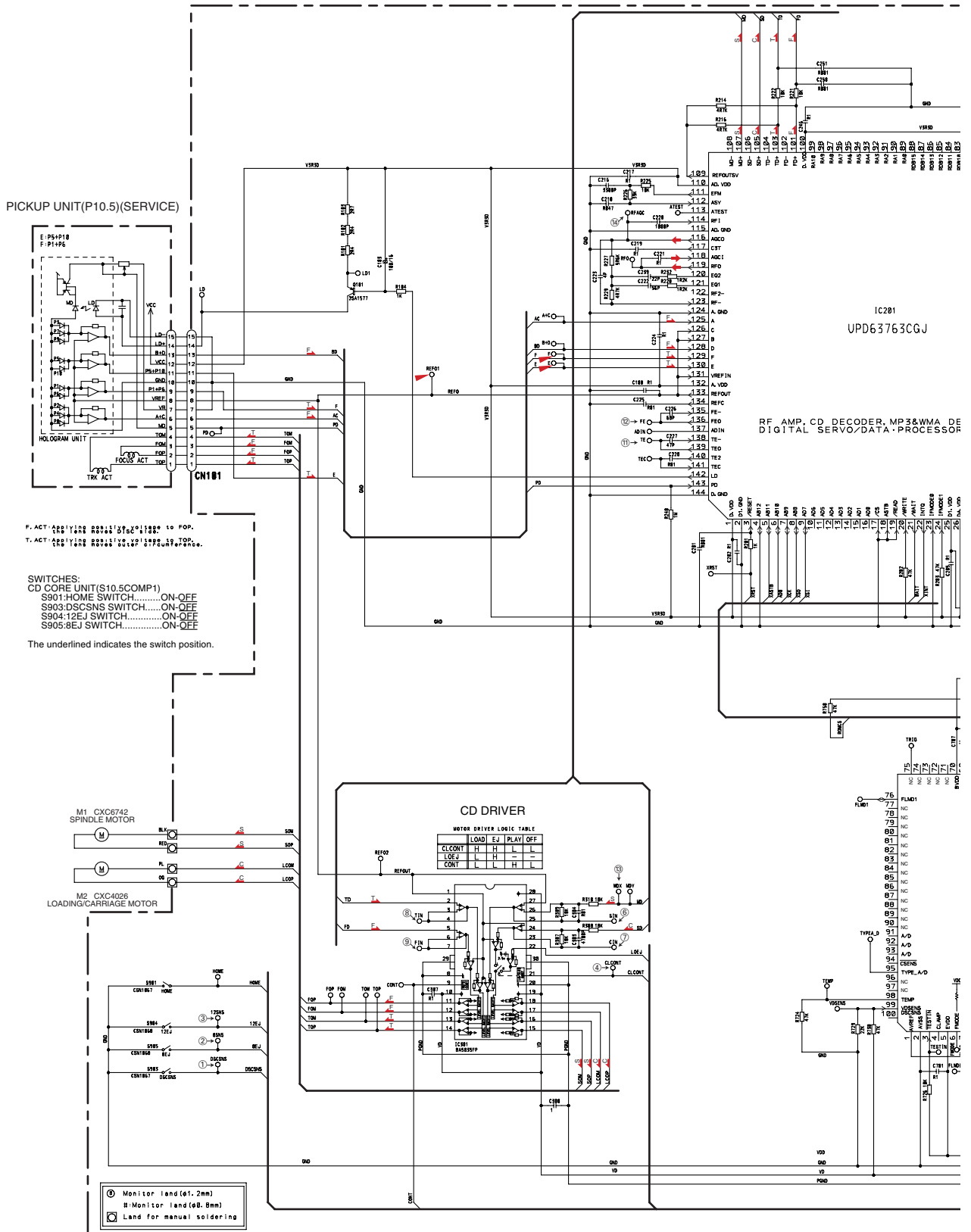

NOTE1) GND ... CD LSI, RFAMP, CPU
 PGND ... Actuator, Motor Driver
 AGND ... Audio
 These GND's are not connected to each other on PCB.
 PGND is connected to a floating mechanism part by a screw.

C

A
B
C
D
E
F

C-b

A
B
C
D
E
F

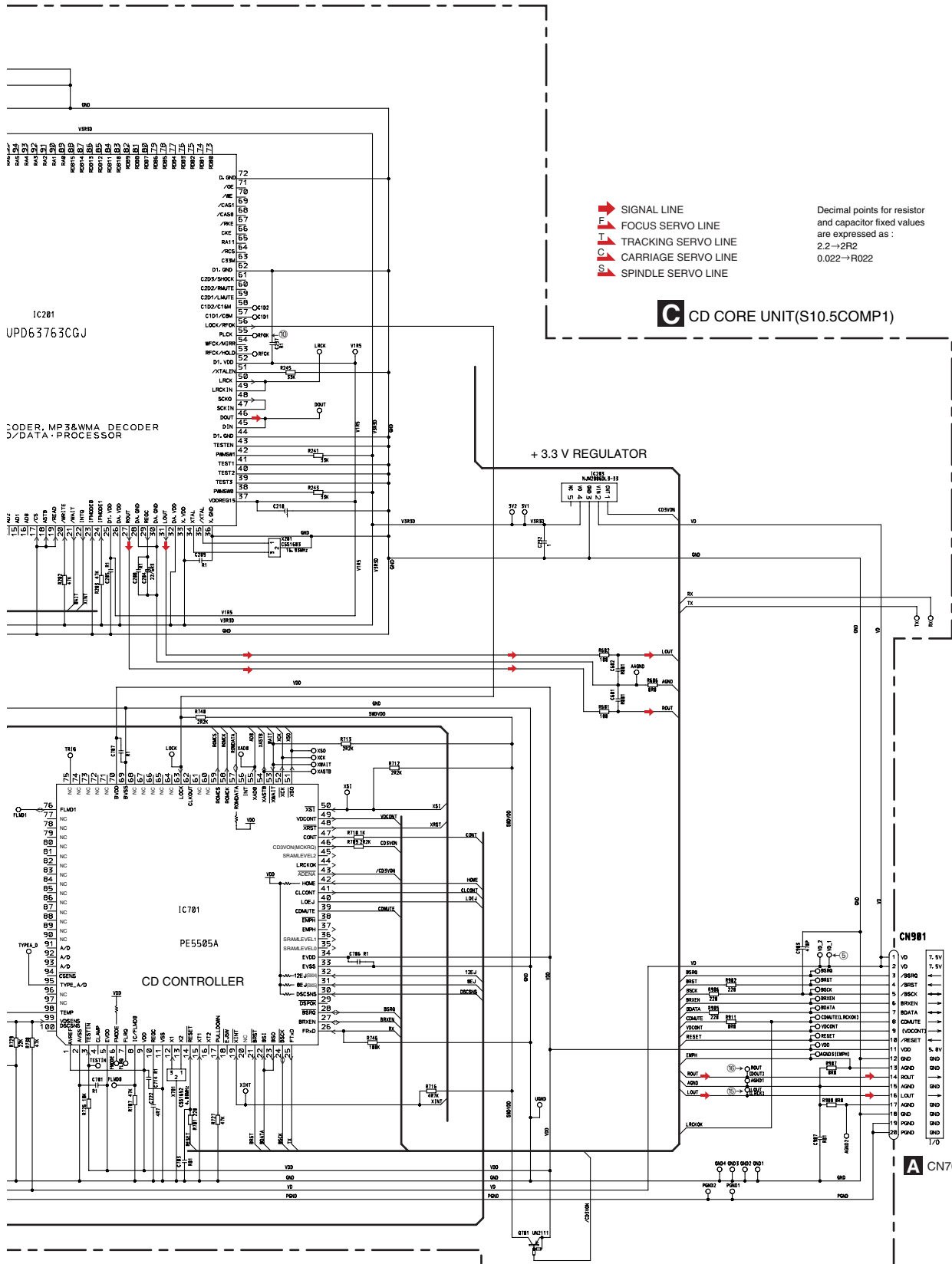

C CD CORE UNIT(S10.5COMP1)

C

www.mobiteh.com